

FSI D30



25 HP KUBOTA DIESEL ENGINE



POWER-CLUTCH

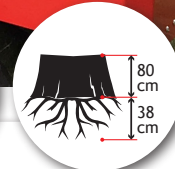
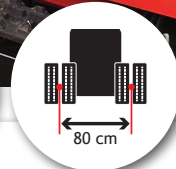

NARROW ACCESS

Remove twin-wheels with a single bolt or retract tracks to decrease machine width

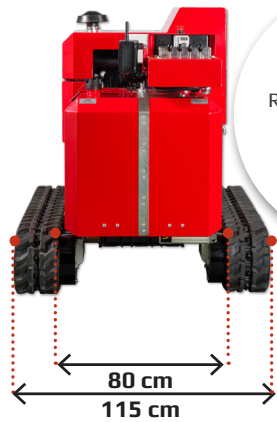

LARGE WORKING AREA

Cover up to 135 cm in one sideways sweep

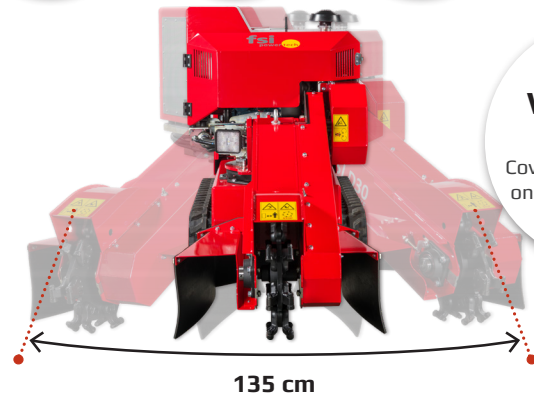

FSI power-clutch

Developed by FSI, this heavy-duty hydraulic clutch with integrated brake is designed specifically for use in stump cutters

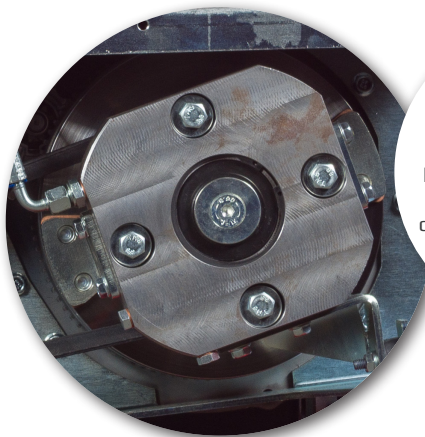

EXCELLENT CONTROL

With the pivoting console or radio control the operator has a great view of the working area at a safe distance



POWER-CLUTCH

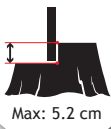

Max: 5.2 cm

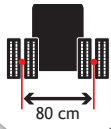

80 cm

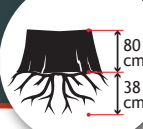

80 cm
38 cm



135 cm

fsi
power tech



FSI D30

For the professional user who cuts stumps regularly

- V-belt drive for optimal power transmission
- FSI power-clutch - powerful hydraulic clutch with active brake
- Fast braking of cutter disc on disengaging
- LED work light
- Easily accessible lashing & lifting points
- Tool set
- Integrated toolbox
- OPTION: FSI power-sweep - intelligent sweep controller for top performance

FSI D30

- Hydraulic 2WD, with mechanical differential lock for better mobility and increased traction
- 90 degrees swivel control panel, provides excellent visibility of the cutting area
- Twin wheels with centre bolt for easy fitting/removing
- Safety bar, disengaging the cutter wheel upon release

FSI D30 TRACK

- Expanding and retracting rubber tracks
- 90 degrees swivel control panel, provides excellent visibility of the cutting area
- Safety bar, disengaging the cutter wheel upon release

FSI D30 TRACK REMOTE

- Expanding and retracting rubber tracks
- Control panel with basic operating functions
- Scanreco radio remote control with extra battery, battery charger and cable

Engine	
Engine size / type	18.5 kW / 25 HP Kubota
Fuel type	Diesel
Tank capacity	35 l
Cutting Head	
Diameter	470 mm
Tooth system	FSI 25 - 3 x rotatable
No. of teeth	16
Clutch	FSI power-clutch
Cutter wheel drive	V-belt
Sweep system	Hydraulic sweep
Cutting range	
Above ground level	80 cm
Below ground level	38 cm
Sweep width	135 cm
Max cutting depth	5.2 cm per sweep

Drive system	2WD	TRACK/ TRACK REMOTE
Ground drive	2WD Hydraulic	Tracks
Traction wheels	Ø450 x 180, 8 ply	N/A
Twin wheel	Ø450 x 210, 10 ply	N/A
Steering wheels	Ø410 x 110, 8 ply	N/A
Brake	Automatic	
Dimension	2WD	TRACK/ TRACK REMOTE
Length	2700 mm (3020 with dozer)	
Width	800 mm	800 mm
with twin wheels	1350 mm	
with extended tracks		1150 mm
Height	1220 mm	
Weight	810 kg	970 kg
Optionals	2WD	TRACK/ TRACK REMOTE
	Twin wheels with tractor profile	Dozer blade with extensions
	FSI power-sweep	
	Document tube	